



NewTechWood[®]

CLADDING TRIMS

Technical Specifications



OUTLINE

| | | | |
|-----------------------------|-----------|--------------------------------|-----------|
| <i>SPECIFICATION</i> | 3 | <i>INSTALLATION</i> | 17 |
| Material | 3 | Vertical Installation (13mm) | 17 |
| Colours Available | 4 | Horizontal Installation (13mm) | 18 |
| Classification of Trims | 7 | Vertical Installation (25mm) | 19 |
| Sizes of Trims | 10 | Horizontal Installation (25mm) | 20 |
| | | | |
| <i>INSTALLATION</i> | 11 | <i>GALLERY</i> | 21 |
| Vertical | 11 | | |
| Horizontal | 12 | | |
| Vertical for Window | 13 | | |
| Horizontal for Window | 15 | | |

SPECIFICATION - Material

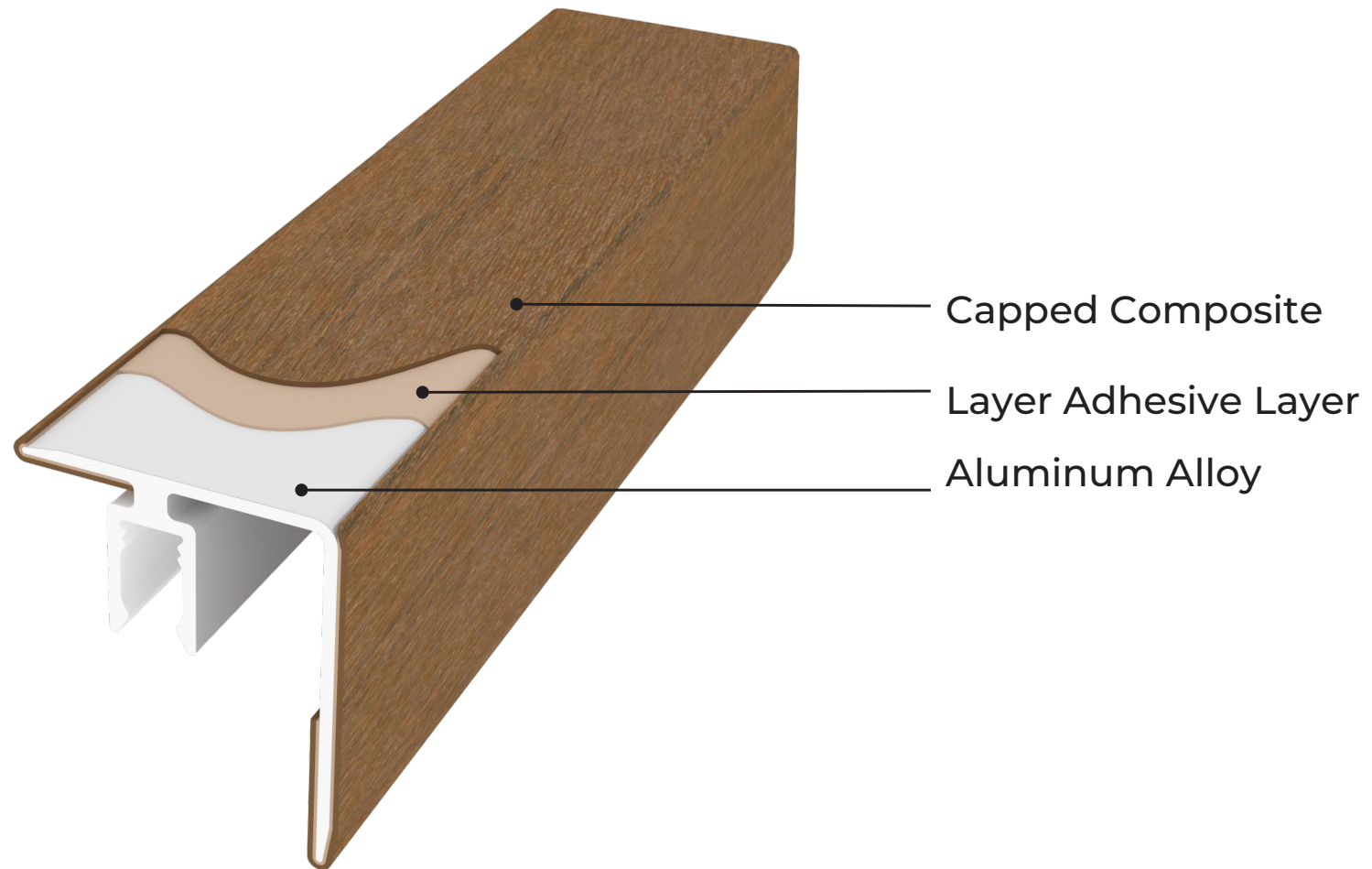

SPECIFICATION - Colours Available, Shadowline Cladding



Blackbutt
(BB)

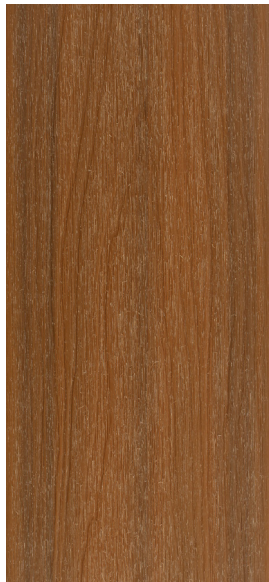

Teak
(TK)



Ipe
(IP)



Sea Salt
(SS)



Ebony
(EB)
Shou Shugi Ban

SPECIFICATION - Colours Available, Castellated Cladding (50mm Rib)



Blackbutt
(BB)



Teak
(TK)



Aged Wood
(AW)



Ebony
(EB)

SPECIFICATION - Colours Available, Castellated Cladding (25mm Rib)



Canadian Cedar
(CC)





Ipe
(IP)



Ebony
(EB)

SPECIFICATION - Classification of Trims

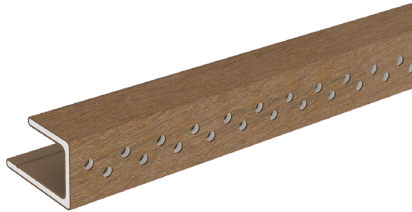
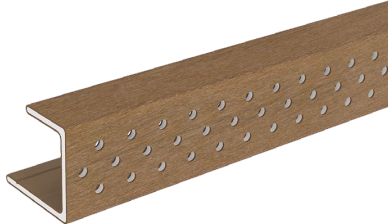
| Description | F-Trim | Outside Corner Trim | Inside Corner Trim | H-Trim |
|---------------------|---|--|---|---|
| Where to use | Outermost Edge | Outside Corner | Inside Corner | Butt Joint Installation |
| Picture |  |  |  |  |

| Name | Flashing | J Trim Perforated (For 13mm Board) | J Trim Perforated (For 25mm Board) | J Trim Non-Perforated (For both 13mm&25mm) |
|---------------------|--|--|---|---|
| Where to use | <ul style="list-style-type: none"> Window Head Window Sill Butt Joint | Bottom of the Cladding panel | Bottom of the Cladding panel | Edging for Cladding |
| Picture |  |  |  |  |

SPECIFICATION - Size of Trims for 13mm Thickness Cladding Board

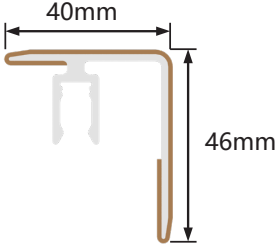
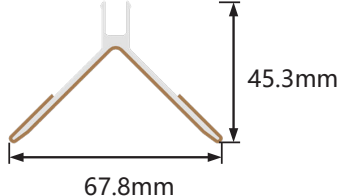
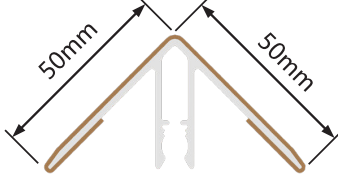
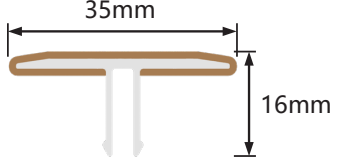
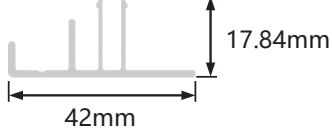
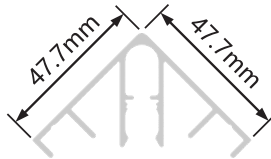
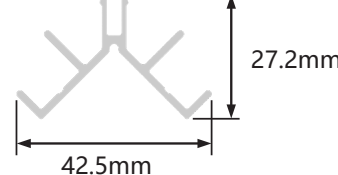
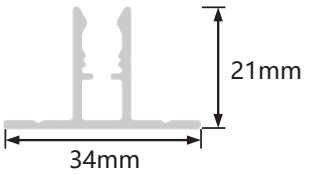
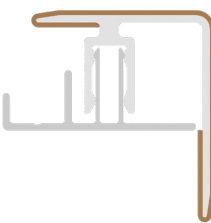
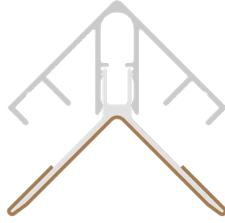
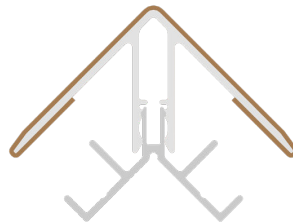
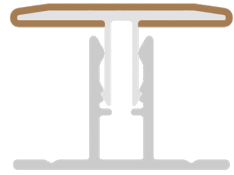
| Cladding Board Thickness (Shadowline and Shou Sugi Ban) | Item | F-Trim (Outermost Edge) Previously STUS44 | Inside Corner Trim Previously STUS47 | Outside Corner Trim Previously STUS46 | H-Trim (Butt Joint Installation) Previously STUS45 |
|---|----------|---|---|---|---|
| (13mm) | Cover |  |  |  |  |
| | Coding | CA48 | CA50 | CA51 | CA49 |
| | Base |  |  |  |  |
| | Coding | AA44 | AA46 | AA47 | AA45 |
| | Assembly |  |  |  |  |

SPECIFICATION - Size of Trims for 25mm Thickness Cladding Board

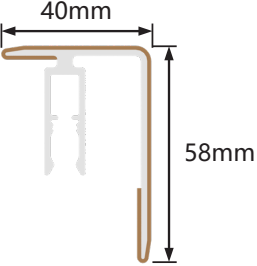
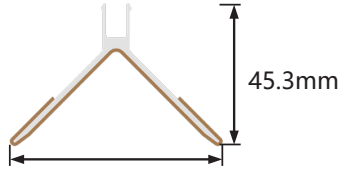
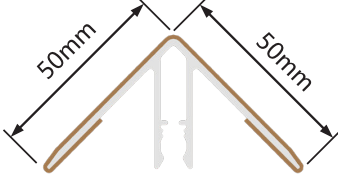
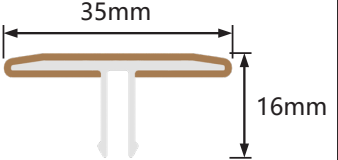
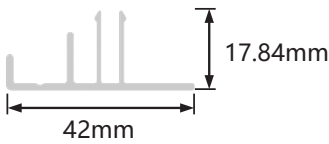
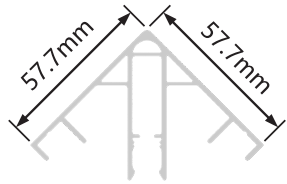
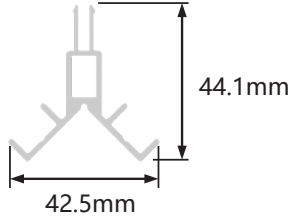
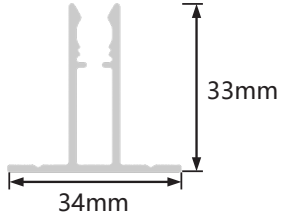
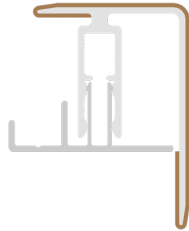
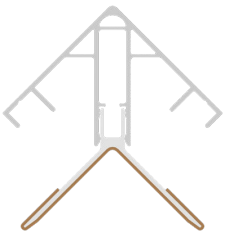
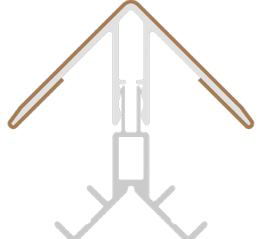
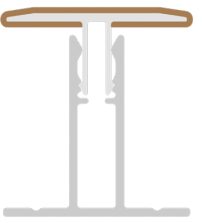
| Cladding Board Thickness (Three Rib and Five Rib Castellations) | Item | F-Trim (Outermost Edge) Previously UH50 | Inside Corner Trim | Outside Corner Trim Previously UH51 | H-Trim (Butt Joint Installation) |
|---|----------|---|---|---|---|
| (25mm) | Cover |  |  |  |  |
| | Coding | CA63 | CA50 | CA51 | CA49 |
| | Base |  |  |  |  |
| | Coding | AA44 | AA61 | AA62 | AA60 |
| | Assembly |  |  |  |  |

SPECIFICATION - Size of Window & Edging Trims

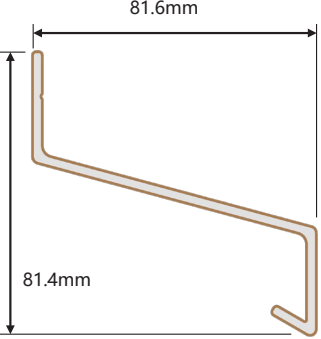
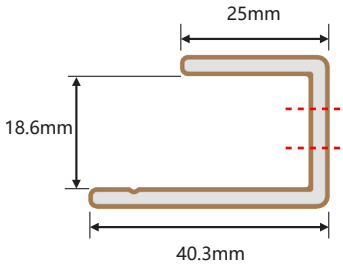
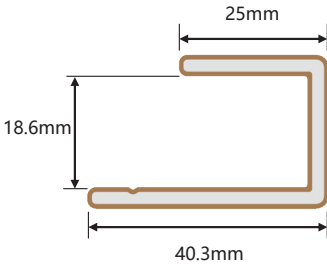
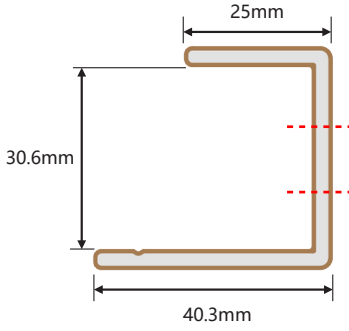
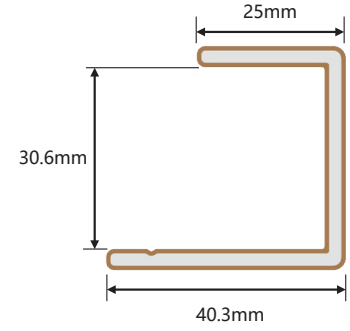
| Flashing | J-Trim Perforated For Shadowline and Shou Sugi Ban | J-Trim Non-Perforated For Shadowline and Shou Sugi Ban | J-Trim Perforated For Castellation Cladding | J-Trim Non-Perforated For Castellation Cladding |
|---|--|---|--|--|
|  |  |  |  |  |
| CA41 | CA42 | CA42B | CA43 | CA43B |

INSTALLATION - Vertical



Side View

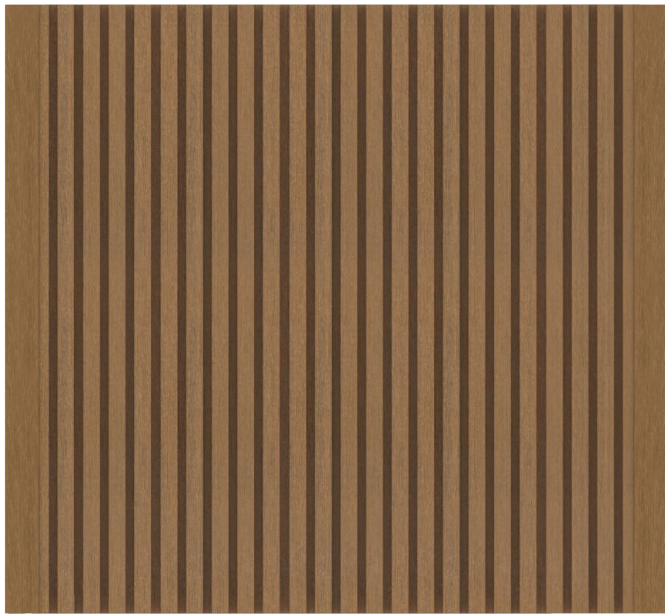

Front View

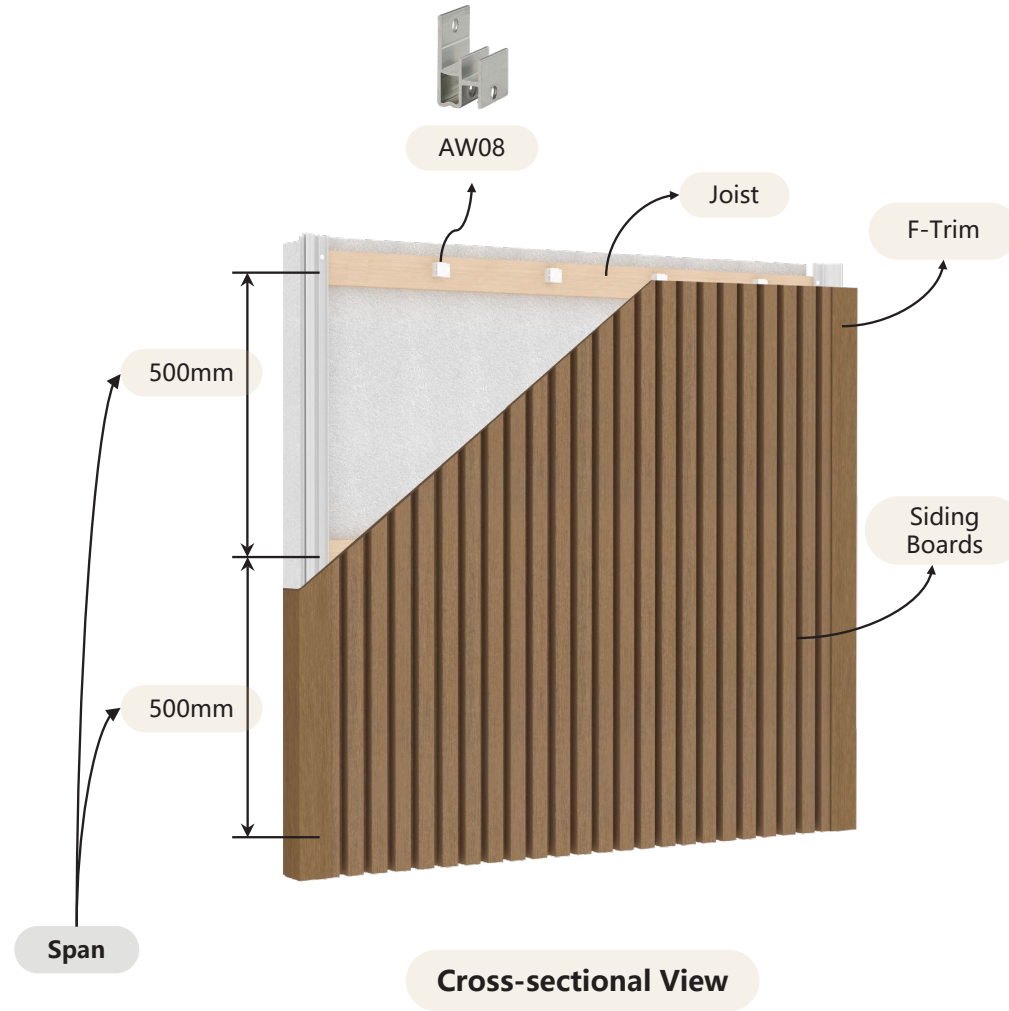

INSTALLATION - Horizontal

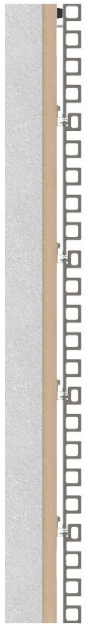

Side View



Front View

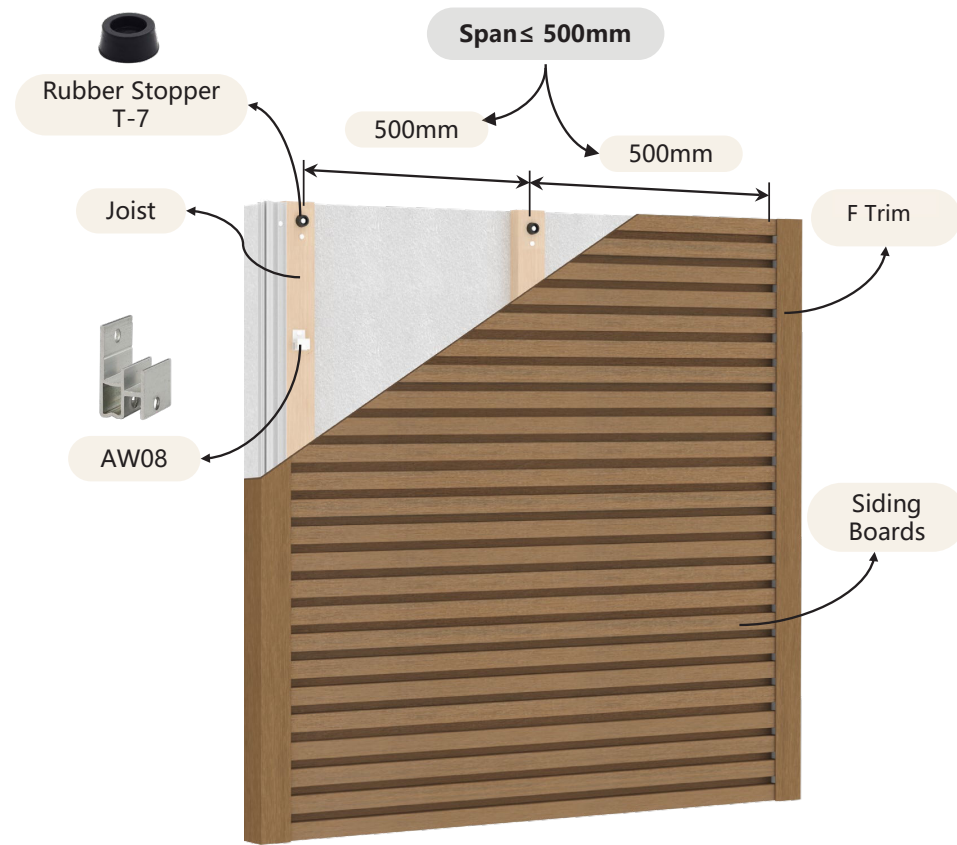

Cross-sectional View

INSTALLATION - Vertical for Window

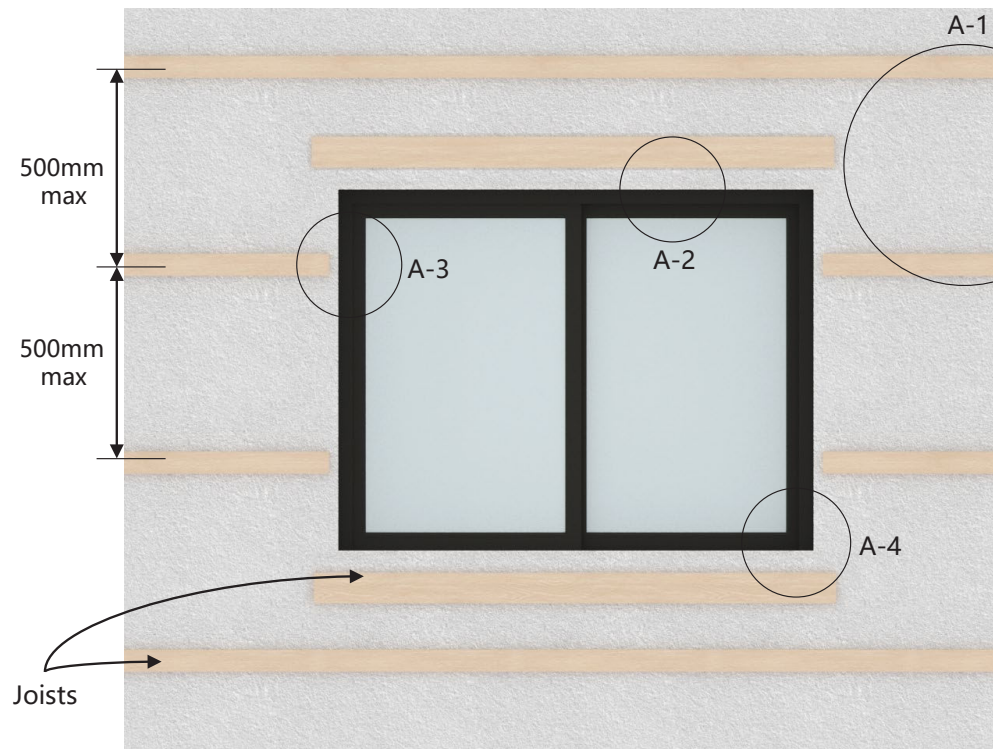

Joists Layout

A-1:
The span is at a max. of 500mm.

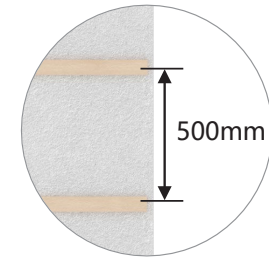

A-1

A-2/A-3:
Reserve space for installing edge banding panels

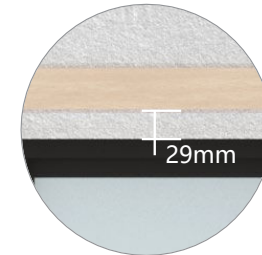

A-2

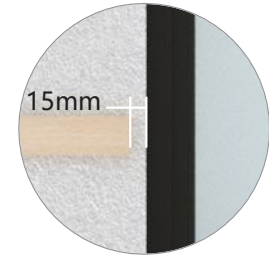

A-3

A-4:
The window head and sill joist width is at a min. of 100 mm. Its length is longer than the window frame at a distance of 80mm.

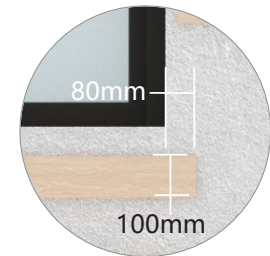

A-4

INSTALLATION - Vertical for Window

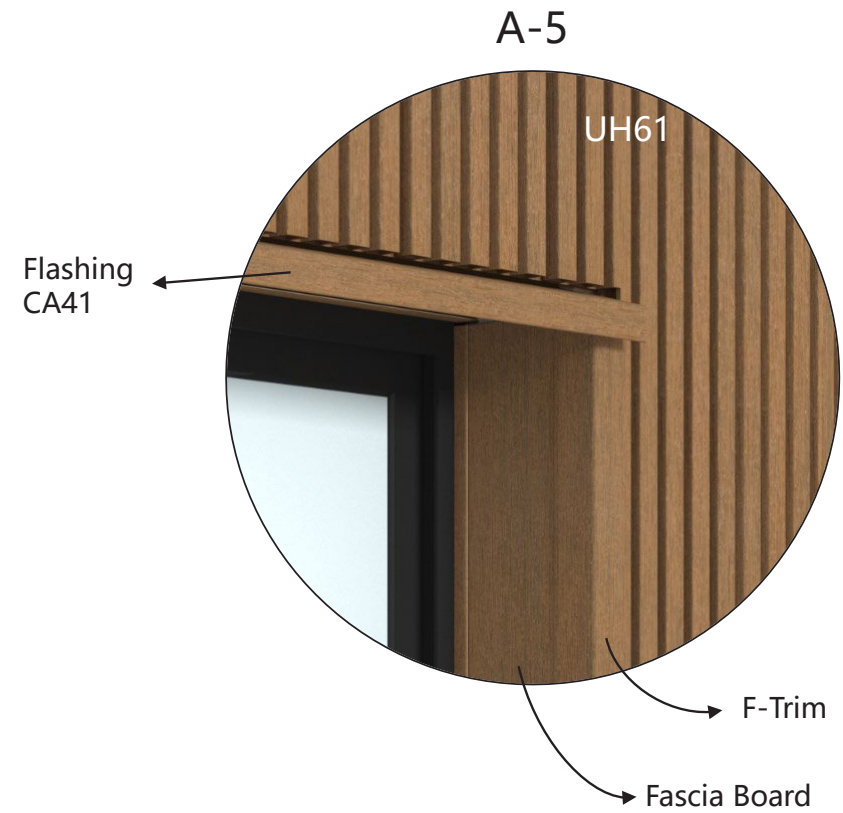
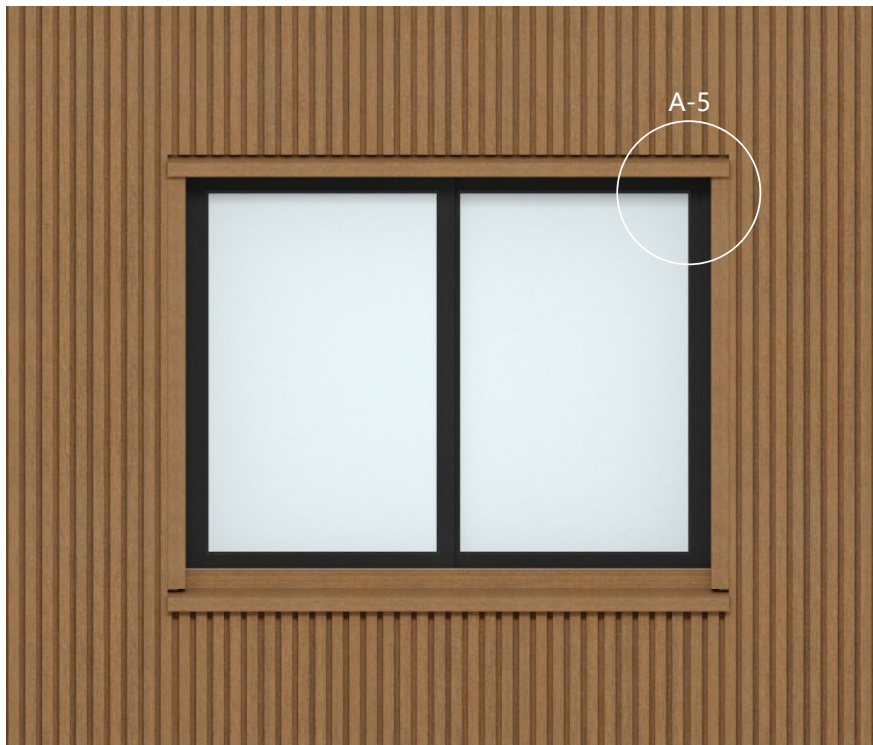

INSTALLATION - Horizontal for Window

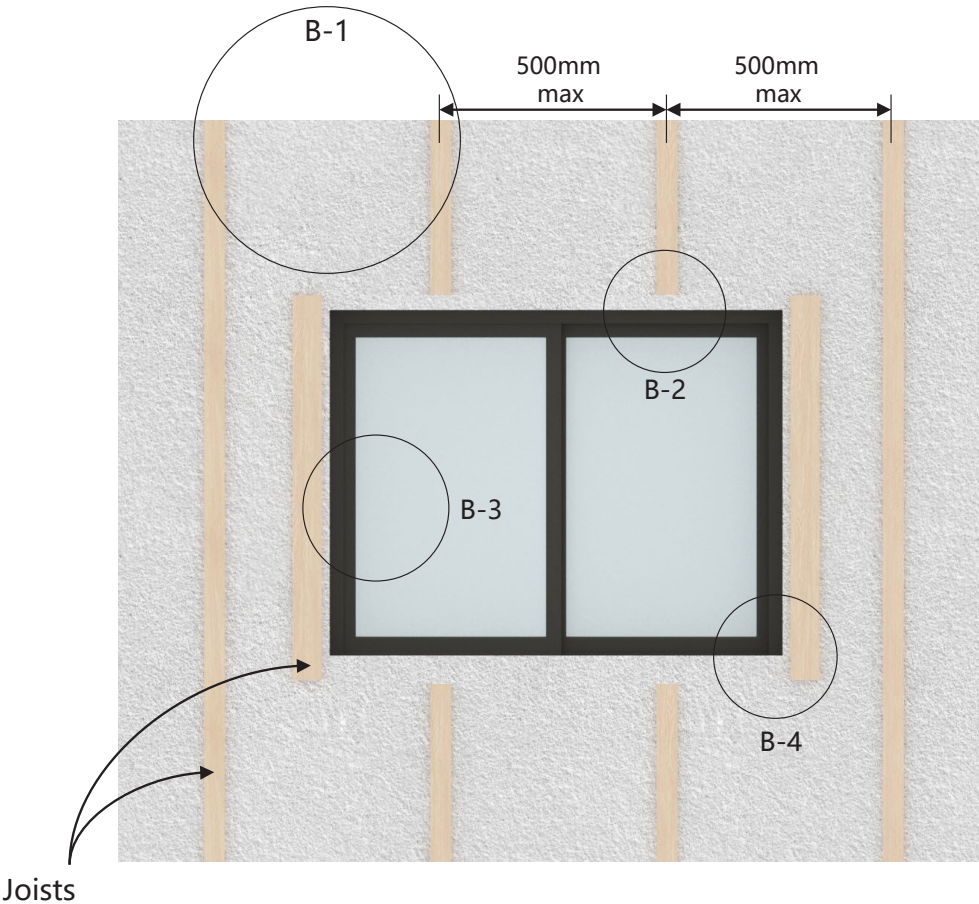

Joists Layout

B-1:
The span is at a max. of 500mm

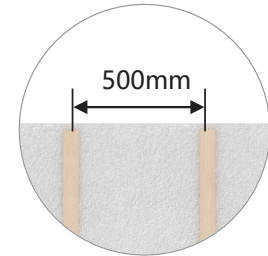

B-1

B-2/B-3:
Reserve space for installing edge banding panels

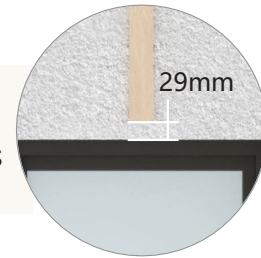

B-2

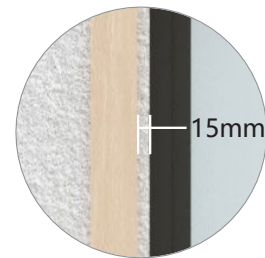

B-3

B-4:
The window head and sill joist width is at a min. of 100 mm. Its length is longer than the window jamb at a distance of 80mm

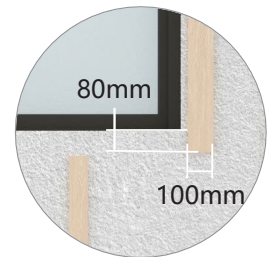

B-4

INSTALLATION - Horizontal for Window

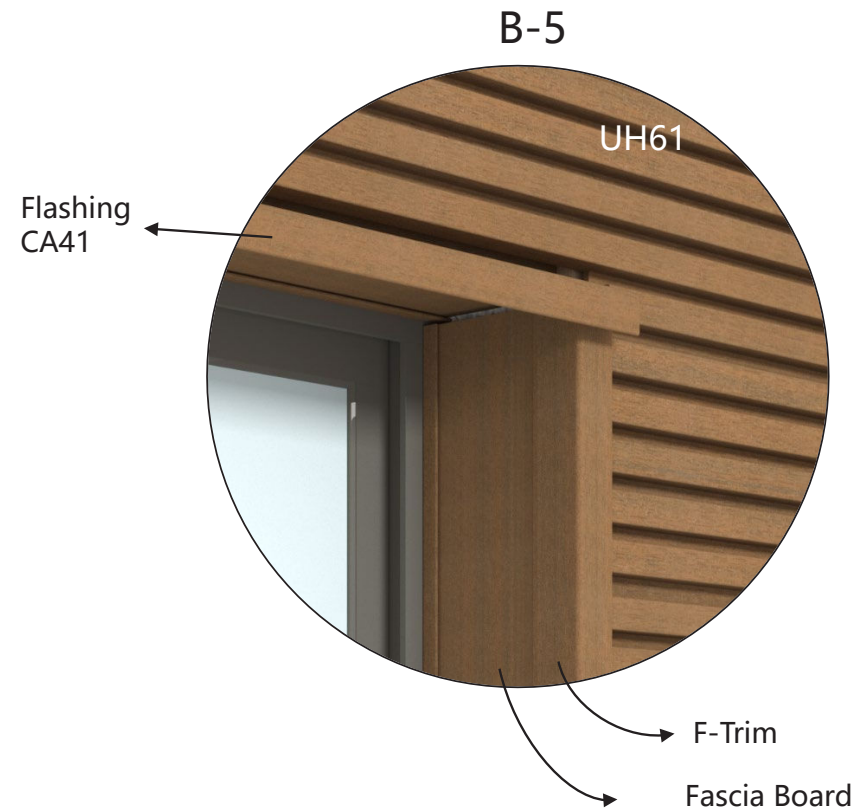
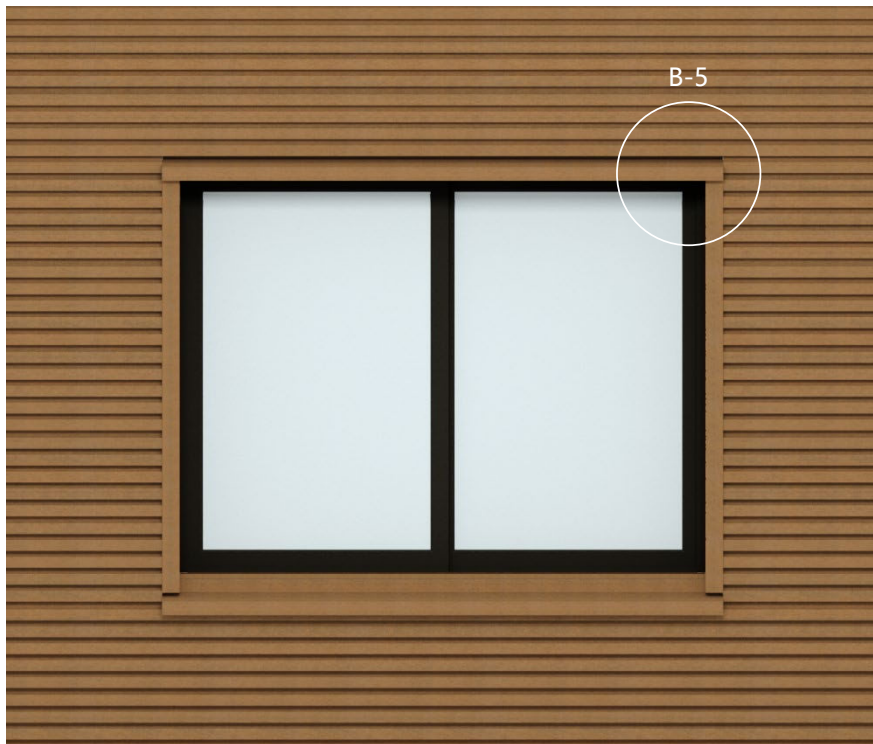

APPLICATION - Vertical Installation for 13mm Cladding Board

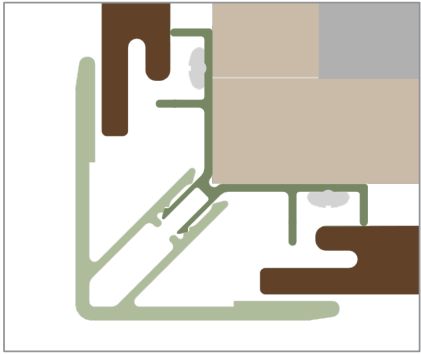

Outside Corner
(Outside Corner Trim)

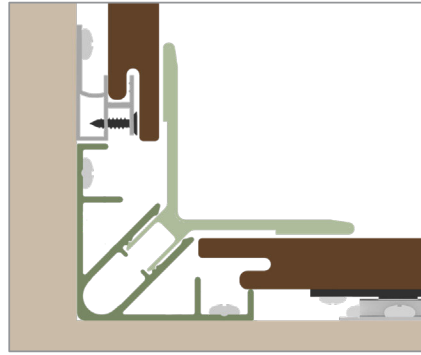

Inside Corner
(Inside Corner Trim)

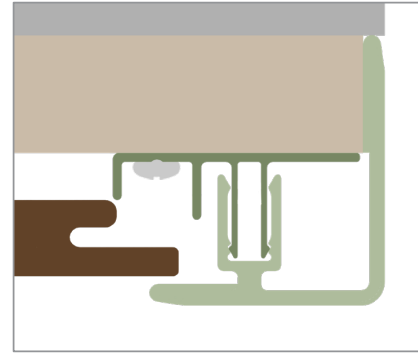

Outermost Edge
(F-Trim)

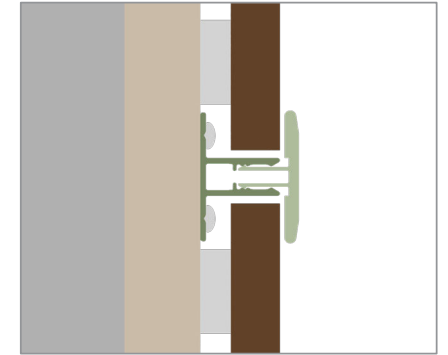

Butt-Joint
(H-Trim)

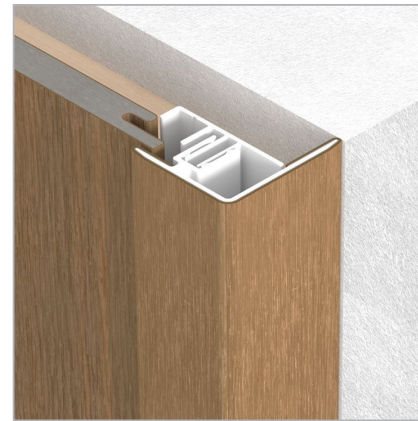
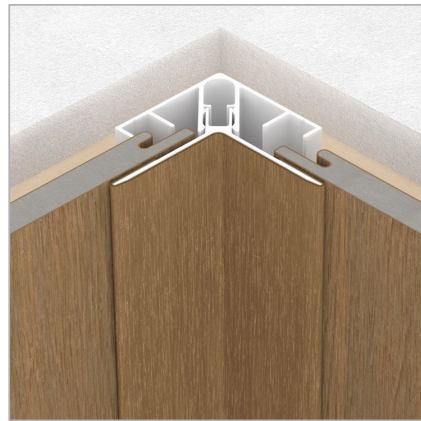

APPLICATION - Horizontal Installation for 13mm Cladding Board

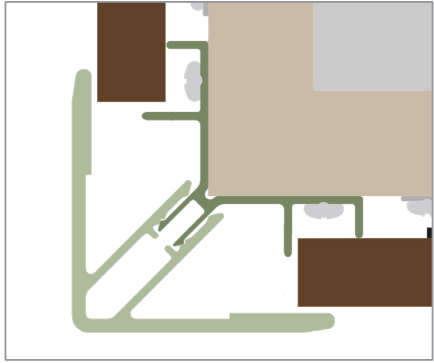

Outside Corner
(Outside Corner Trim)

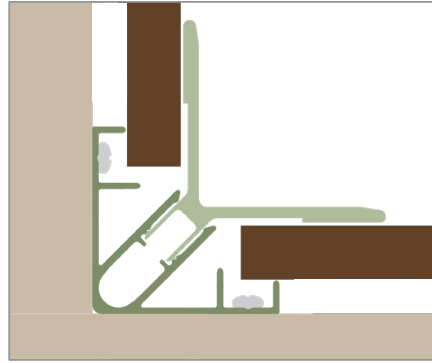

Inside Corner
(Inside Corner Trim)

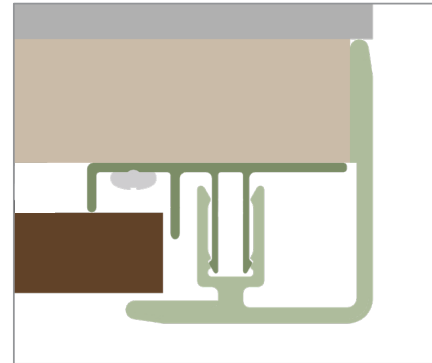

Outermost Edge
(F-Trim)

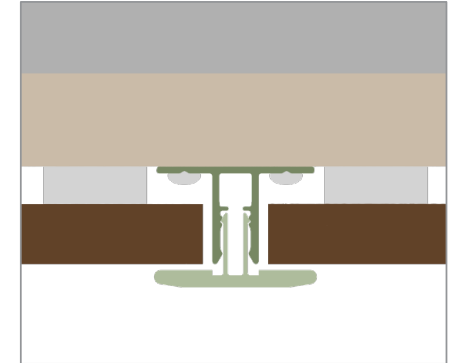

Butt-Joint
(H-Trim)

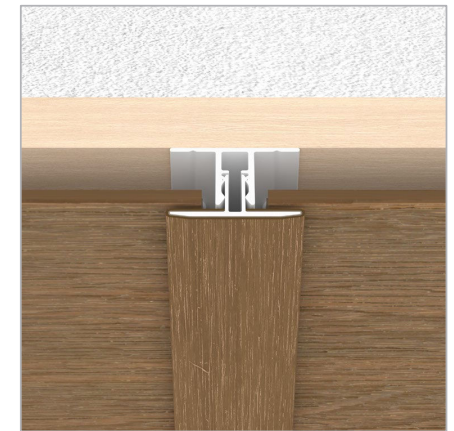
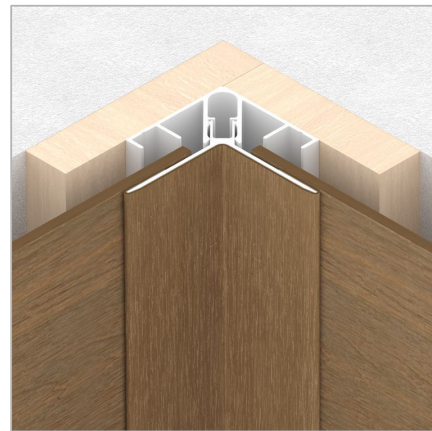
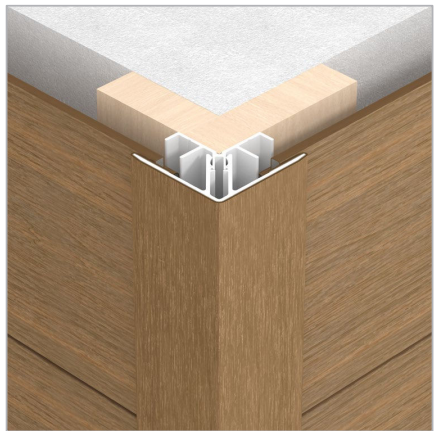

APPLICATION - Vertical Installation for 25mm Cladding Board

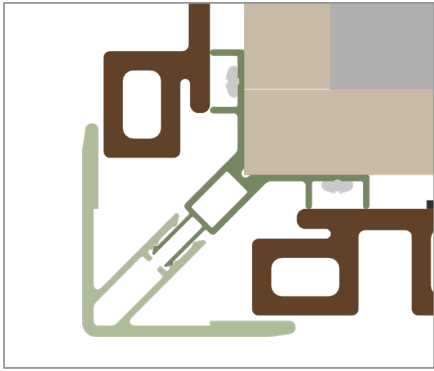

Outside Corner
(Outside Corner Trim)



Inside Corner
(Inside Corner Trim)

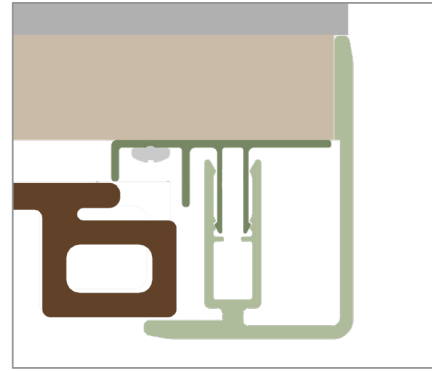

Outermost Edge
(F-Trim)

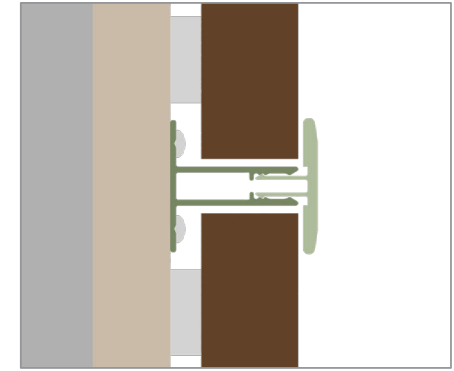

Butt-Joint
(H-Trim)

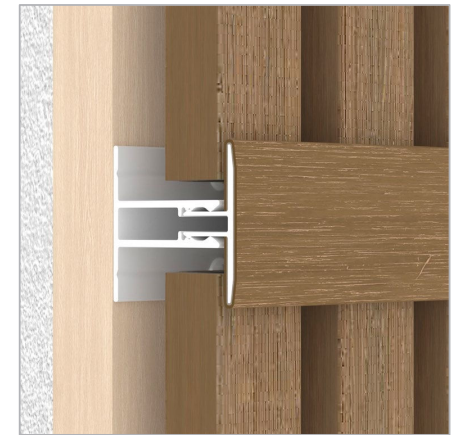
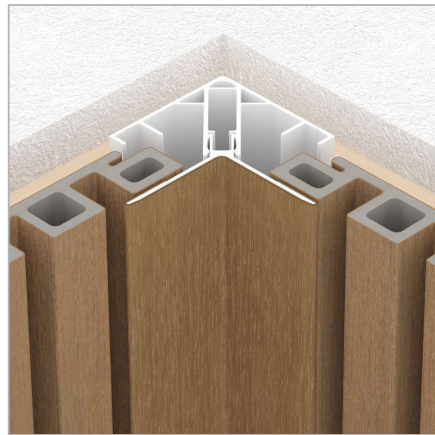
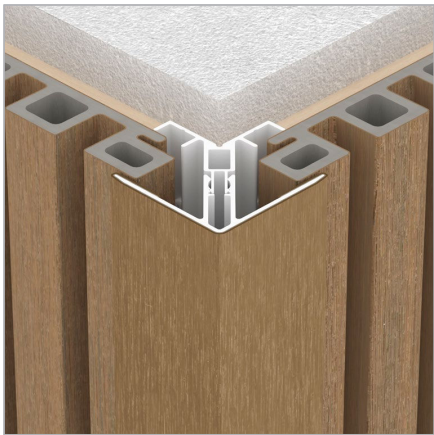

APPLICATION - Horizontal Installation for 25mm Cladding Board

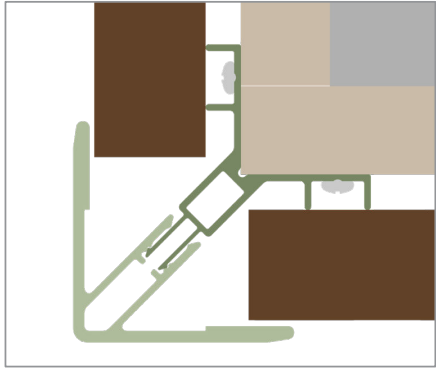

Outside Corner
(Outside Corner Trim)

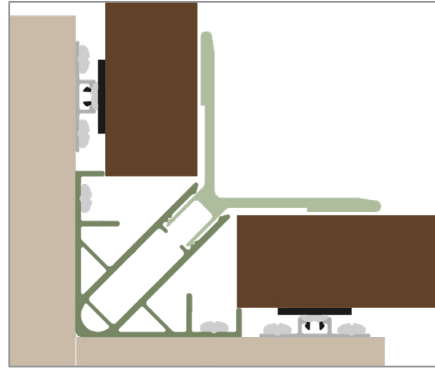

Inside Corner
(Inside Corner Trim)

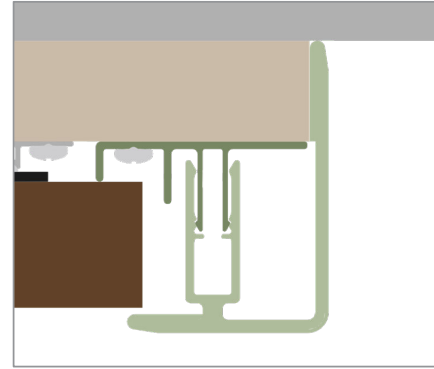

Outermost Edge
(F-Trim)

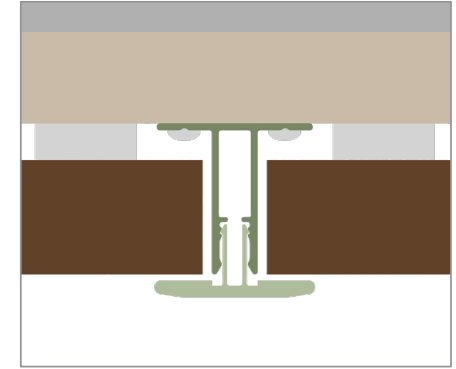

Butt-Joint
(H-Trim)

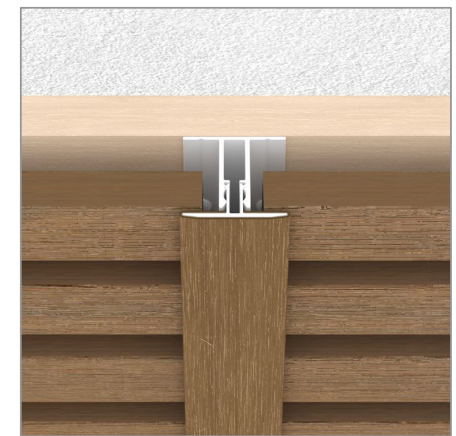
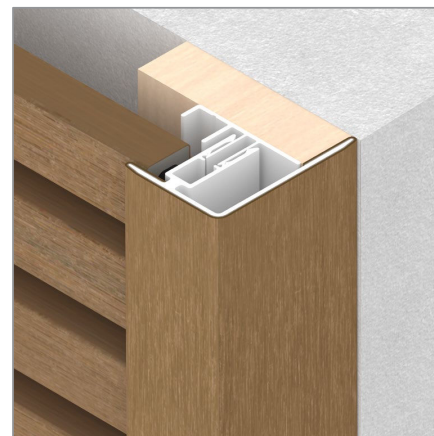
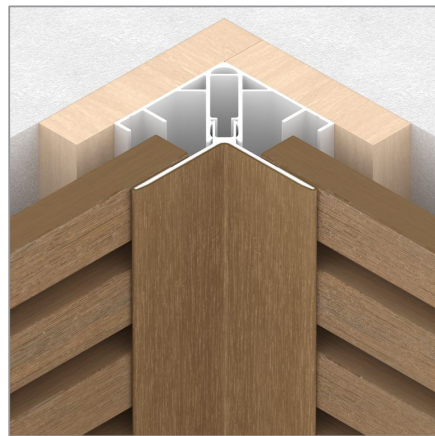
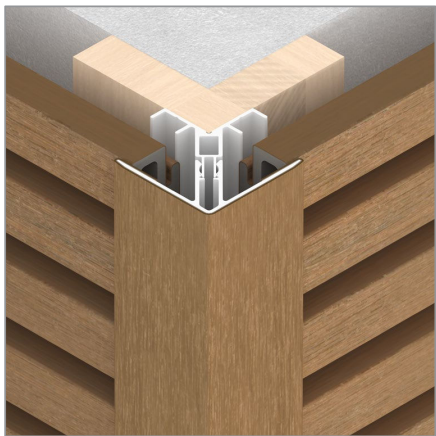

GALLERY



GALLERY



R2_v20240715